

U-Series

Subsea Screw Jacks & Bevel Gearboxes



 **POWER JACKS**
Lifting and Positioning Solutions

The Power Jacks

U-Series: strength in depth

The U-Series is a new proposition from Power Jacks: a range of subsea products specifically designed to operate at maximum efficiency in an underwater environment.

The U-Series range includes the Subsea Screw Jack and Subsea Bevel Gearbox, with proven depth ratings of up to 3000m as standard, and the design capabilities to go even deeper if required.

A long-established specialist in electro-mechanical jacking and actuation, we already supply linear motion and mechanical rotary power transmission in subsea applications. With the U-Series, we've added a new dimension to our subsea service offering to the offshore oil & gas industry.

And because it's based on engineering experience and expertise that have served Power Jacks customers well for more than a century, you know it's designed to the highest standards – and manufactured to last.

New subsea options... new confidence in your operations.



Performance

THEY POSSESS ALL THE QUALITIES YOU'D EXPECT OF POWER JACKS PRODUCTS – STRENGTH, RELIABILITY, DURABILITY AND HIGH PERFORMANCE. AND THAT MEANS THEY'RE IDEALLY SUITED TO OPERATE IN THE TOUGHEST SUBSEA CONDITIONS, ANYWHERE IN THE WORLD.

Electro-mechanical jacking and actuation: what it means for you

Higher Performance

- Accurate and smooth delivery of force
- Wide range of actuation as the stroke position is easily and quickly varied
- Resistant to a wide range of temperature variations
- Complete control of the entire motion profile using standard control methods
- Repeatable and accurate positioning

Reduced Costs

- Generally cheaper in comparison to a hydraulic system when the required ancillary hydraulic equipment is included
- Machinery requires less maintenance
- Less manual intervention on machinery to set up processes
- Reduced downtime caused by hazardous fluid leaks
- Only use power when moving the load

Increased Safety

- Screw Jacks can be self-locking so hold position even with no power connection
- No high-pressure oil leaks

Easier To Control

- Easy to install using standard mechanical and electrical solutions
- Controls simple to programme and tune, even for multiple synchronised axes
- Simple mechanical shaft or electric cable extensions for systems spanning long distances
- No risk of loss of pressure or leaks in long pipe runs, as can be the case with hydraulics

More Environmentally Friendly

- No hazardous hydraulic fluid - so risk of contaminating the environment is significantly reduced or eliminated entirely
- Reduced health and safety requirements due to absence of hazardous hydraulic fluid
- No need to dispose of hydraulic fluid at any point during or after operations



The Power Jacks

U-Series: Whatever you need them for...

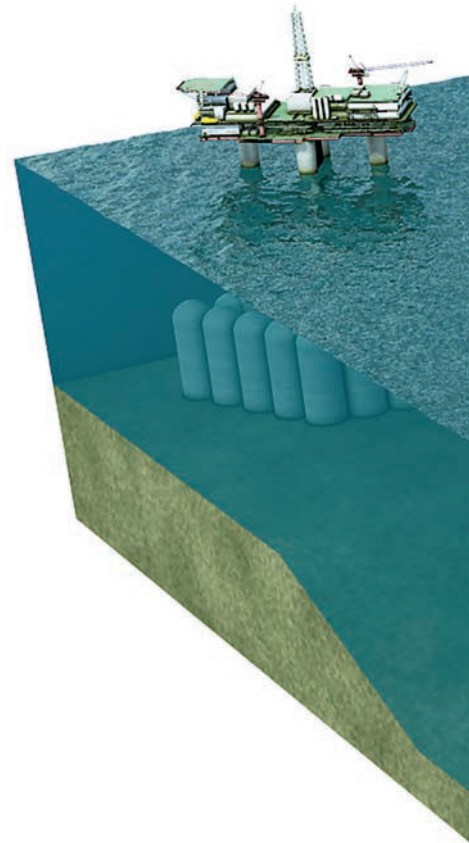

Choke Clamp



TDU Positioning



Subsea Riser Positioning

Subsea Screw Jacks



Rotating Screw



Translating Screw

Linear motion and positioning to perform tasks such as:

- Tilt/Pivot
- Lift/Lower
- Position
- Roll/Slide
- Open/Close
- Tension
- Lock/Unlock

Bevel Gearboxes



For applications when you need mechanical rotary power transmission to:

- Turn through 90° angle
- Be split into multiple drive lines
- Reduce the speed of the mechanical drive
- Adjust rotational position
- Deliver a combination of all of the above – in one unit

Typical Applications

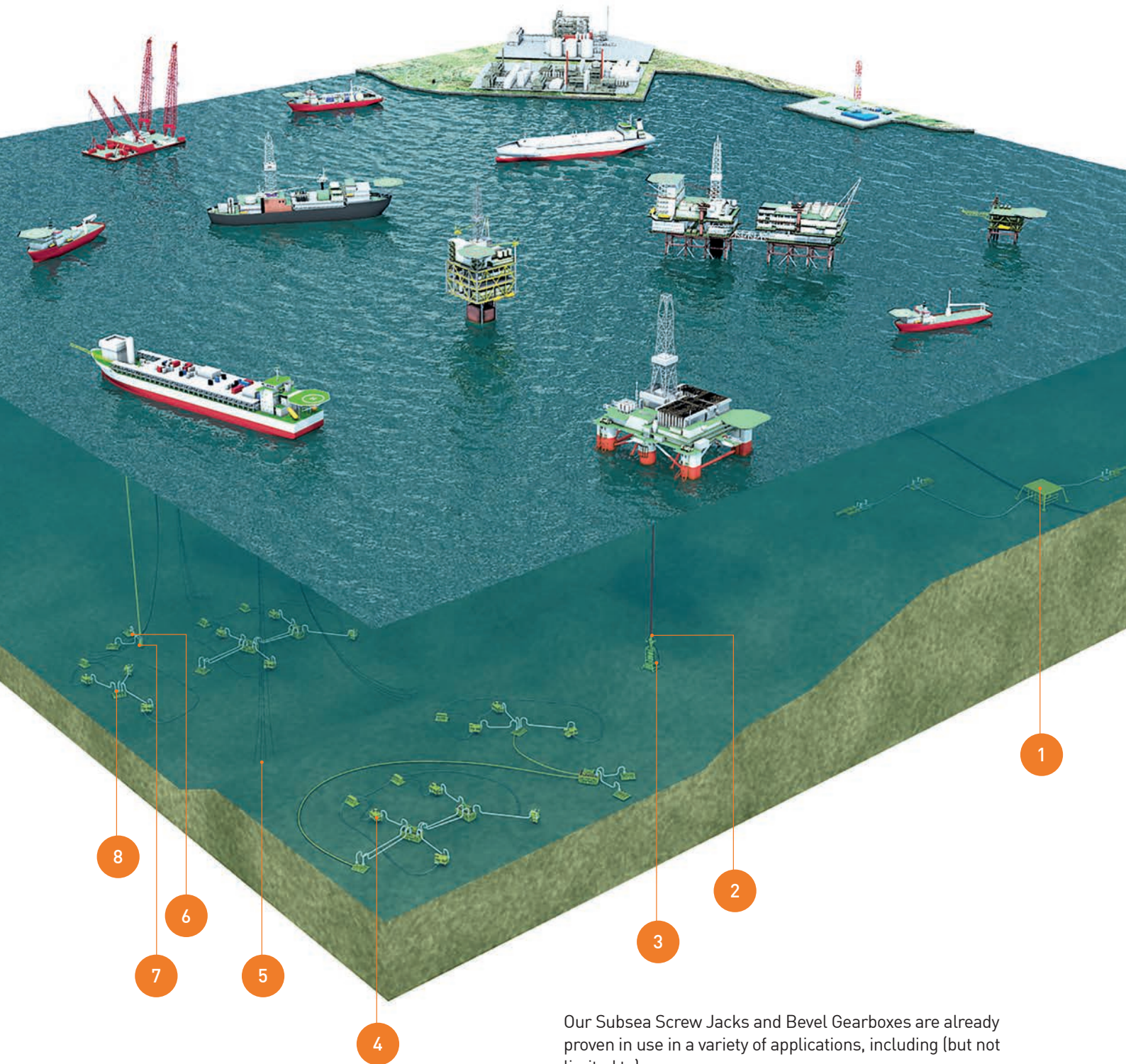

Our Subsea Screw Jacks and Bevel Gearboxes are already proven in use in a variety of applications, including (but not limited to):

1. Pig launch/Receiver Positioning
2. ESP umbilical connector actuator
3. Raising and lowering subsea caisson
4. ROV operated clamp connector
5. Locking pin push-pull actuator for FPSO mooring chain
6. ROV operated clamp release mechanism for pipe connector
7. Subsea riser release mechanism
8. Multi quick connector plate drive mechanism (ROV operated) for MQC parking receptacle

The Power Jacks

U-Series: Screw Jacks



Rotating Screw, Upright



Rotating Screw, Inverted



Translating Screw, Upright



Translating Screw, Inverted

- Proven depth ratings up to 3000m subsea as standard (deeper on request)
- Pressure compensated or flooded designs available
- Capacities up to 2000 kN (200Te) as standard
- Capacities up to 35000 kN (3500Te) on request
- Machine Screw Jacks
- Translating and rotating screw configurations
- Full stainless steel Screw Jacks
- Self-locking (the products only use power when moving)
- Anti-rotation mechanism for unconstrained loads
- Anti-backlash mechanism for axial positioning
- Option for reinforced shaft design for up to 300% higher torque transmission
- Reinforced sealing
- Dual nut (safety nut) fail safe load-holding option
- Shock load rated units
- Full range of anti-corrosion options
- ROV drive interfaces
- Low (-65°C) to High (+250°C) temperature solutions available
- Vibration resistant designs
- Full range of feedback devices for speed, position, rotation, wear and load monitoring control
- Special custom designs available to meet your exact requirements

Performance

Full Stainless Steel Construction

Model		UM-0025	UM-0050	UM-0100	UM-0200	UM-0300	UM-0500	UM-1000	UM-1500	UM-2000
Capacity (kN)		25	50	100	200	300	500	1000	1500	2000
Lifting Screw ^{note1}	Diameter X Pitch (mm)	30 x 6	40 x 9	55 x 12	65 x 12	95 x 16	120 x 16	160 x 20	Available on Request	
Gear Ratios	Option 1	6:1	6:1	8:1	8:1	10 ² /3:1	10 ² /3:1	12:1		
	Option 2	24:1	24:1	24:1	24:1	32:1	32:1	36:1		
Turn of worm for raise of lifting screw	Option 1	1 for 1mm	1 for 1.5mm	1 for 1.5mm	1 for 1.5mm	1 for 1.5mm	1 for 1.5mm	3 for 5mm		
	Option 2	4 for 1mm	4 for 1.5mm	2 for 1mm	2 for 1mm	2 for 1mm	2 for 1mm	9 for 5mm		
Maximum Input Power (kW)	Option 1	1.5	3	3.75	3.75	6	11.25	18.5		
	Option 2	0.375	0.55	1.125	1.125	1.9	4.5	8.25		
Start up Torque at full load (Nm) ^{note2}	Option 1	19.8	56	115.9	263.8	480	900	2025		
	Option 2	8.7	25.5	60.5	137	284	504	1119		
Weight (kg) – stroke = 150mm		8.17	15.88	24.72	45	86	195	553		
Weight (kg) per extra 25mm		0.21	0.32	0.57	0.86	1.58	2.49	4.31		
Option 1	Gear Ratio	6:1	6:1	8:1	8:1	10 ² /3:1	10 ² /3:1	12:1		
	Screw jack Static Efficiency	0.201	0.213	0.206	0.181	0.149	0.132	0.131		
	Screw jack Dynamic Efficiency	0.264	0.281	0.272	0.242	0.205	0.181	0.178		
Option 2	Gear Ratio	24:1	24:1	24:1	24:1	32:1	32:1	36:1		
	Screw jack Static Efficiency	0.115	0.117	0.132	0.116	0.084	0.079	0.079		
	Screw jack Dynamic Efficiency	0.167	0.172	0.190	0.169	0.128	0.120	0.123		
Standard Depth Rating	m	3000	3000	3000	3000	3000	3000	3000	3000	
Flooded Design Available		Y	Y	Y	Y	Y	Y	Y	Y	
Pressure Compensated Design Available		Y	Y	Y	Y	Y	Y	Y	Y	

1. All metric machine screws have a trapezoidal thread form, single start as standard (diameter x pitch)
2. For loads of 25% to 100% of Screw Jack capacity, torque requirements are approximately proportional to the load
3. Efficiency values for standard grease lubricated worm gear box and lifting screw
4. For performance of anti-backlash and anti-rotation (keyed) models, consult our Power Jacks experts

Standard construction:

5. Stainless steel Screw Jack rated for rated capacity in tension or compression for static or dynamic movement
6. Lubrication = EP2 Grease
7. Paint finish = Power Jacks Standard Subsea Yellow (other colours available on request)
8. Other materials, plating and paint specifications are available to suit all applications and budgets

Please supply depth rating required with enquiry

Rotating Screw Jacks Configuration

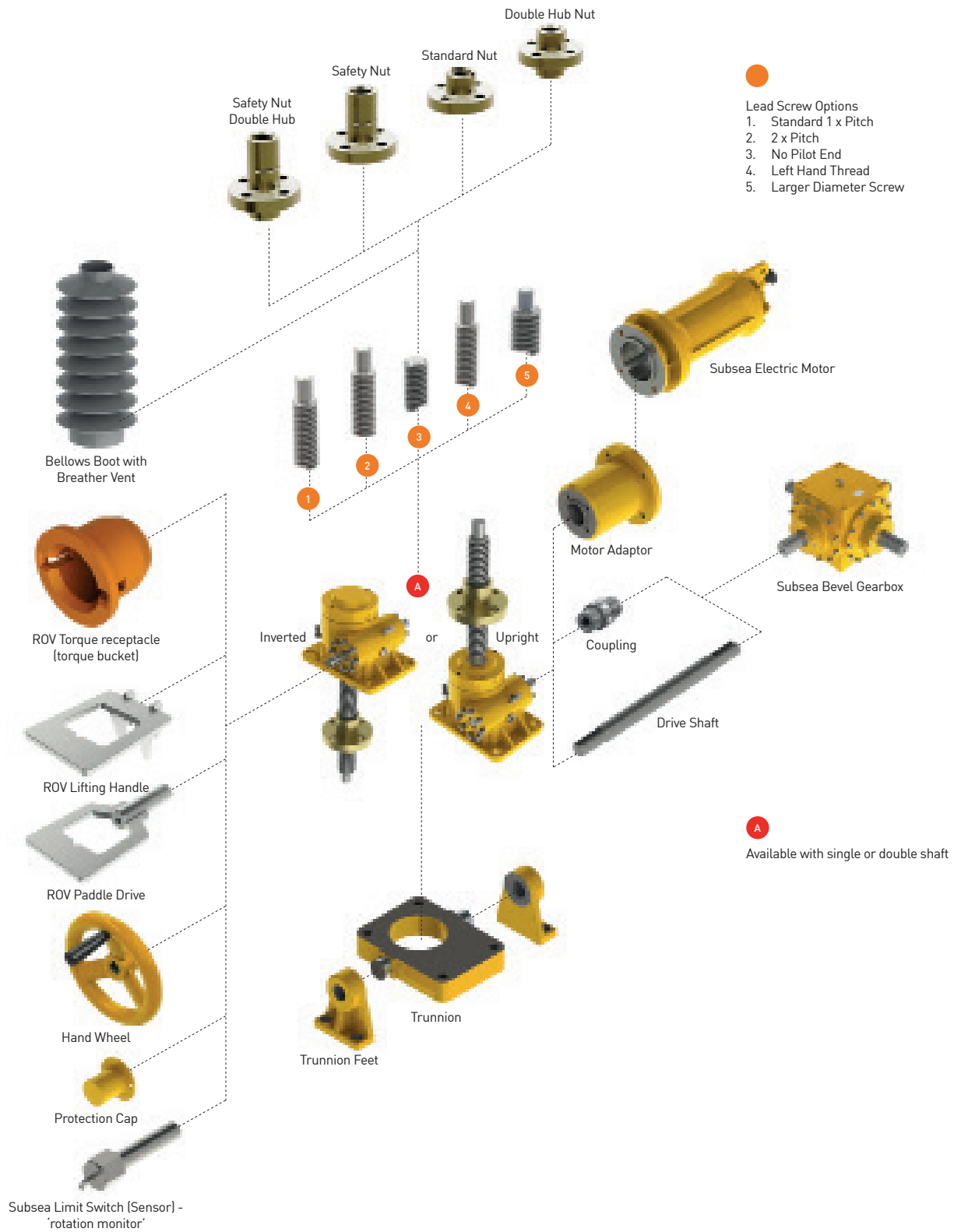

Translating Screw Jacks Configuration

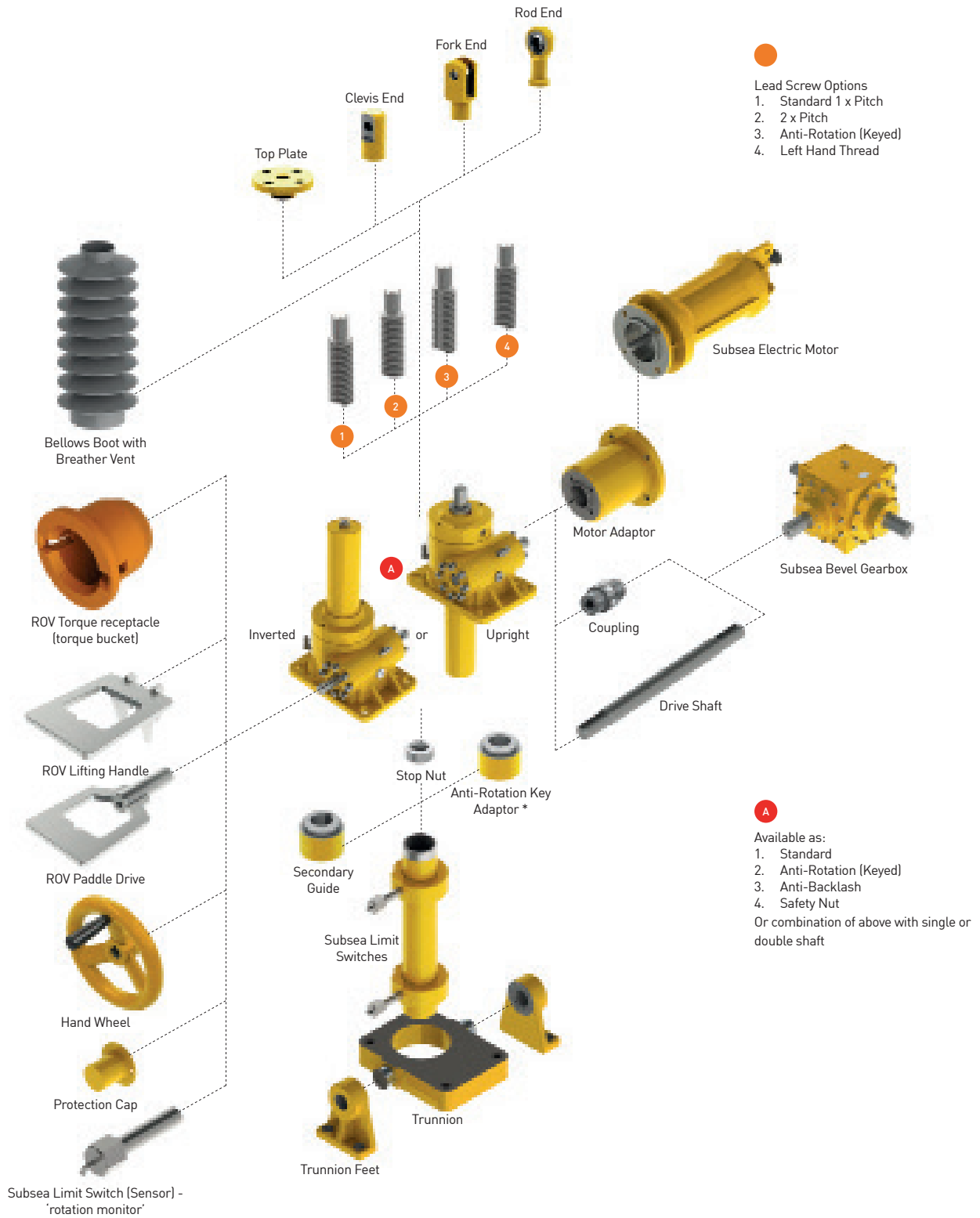

*For use with Anti-Backlash and some Safety Nut models only

The Power Jacks

U-Series: Bevel Gearboxes

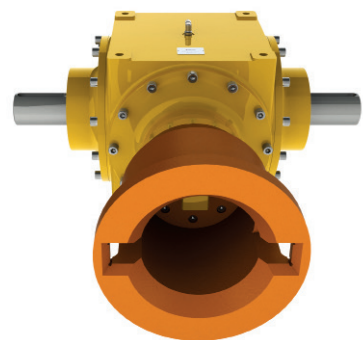
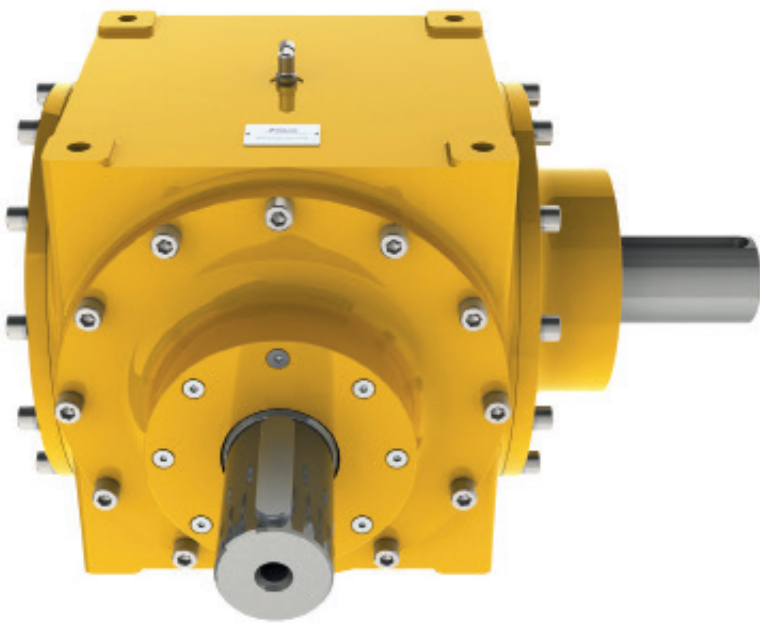

THE U-SERIES SUBSEA BEVEL GEARBOXES:
A PROVEN AND RELIABLE TECHNOLOGY
FOR SUBSEA DRIVE SOLUTIONS.

The range has been developed from Power Jacks' Neeter Drive Range-N bevel gearboxes, which are used worldwide and in most industry sectors – including subsea oil & gas and even submerged nuclear applications.

Performance

Series		35	37	38	39	40	42
Gear Ratios		1:1, 1.5:1, 2:1, 3:1, 4:1 available on all sizes except the 35-Series where the 4:1 ratio is not available					
Torque (Nm)	Nominal ^{#1}	46	115	328	481	1353	6195
	Max Running ^{#2}	93	187	505	935	3088	7000
	Max Start-Up	1 40	281	758	1403	4632	10500
Input Speed	Max (rpm)	3000	3000	3000	3000	3000	3000
Thermal Limit	Power (kW)	3.3	9	20.5	49	90	190
Backlash	arcmin	9 to 16	9 to 16	9 to 16	7 to 10	7 to 10	7 to 10
Efficiency	(%)	95% - 98%					
Service Life	(hours)	>10000	>10000	>10000	>10000	>10000	>10000
Housing Material		SG Iron or Stainless Steel					
Standard Depth Rating	(m)	3000	3000	3000	3000	3000	3000
Flooded Design Available		Y	Y	Y	Y	Y	Y
Pressure Compensated Design Available		Y	Y	Y	Y	Y	Y
Reinforced Shaft Design Available ^{#3}		Y	Y	Y	Y	Y	Y

The above table is set out on the basis of the following nominal values:

1. Shock-free operation
2. Operating time per day = eight hours
3. Maximum 20 starts per hour (torque x 1.5 permissible)
4. Duty cycle 100%
5. When selecting gearboxes take the thermal capacity into consideration
6. Ambient temperature for operation -10° to +50°C permissible

Notes:

#1 Nominal torque values at running speeds of 1500 rpm

#2 Maximum running torque value at speed of 10 rpm

#3 Up to 300% higher torque transmission

Please supply depth rating required with enquiry

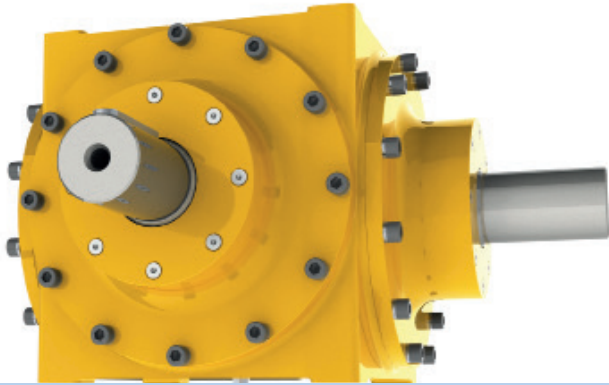

Designed & developed

by an expert team of experienced Power Jacks engineers, the U-Series Subsea Bevel Gearbox has been introduced with a simple objective in mind: to provide our customers with a new solution that's all about versatility.

Subsea Design Features

- Proven depth ratings up to 3000m subsea as (deeper on request)
- Pressure compensated or flooded designs available
- Full stainless steel designs available
- Reinforced sealing
- Full range of anti-corrosion options
- ROV drive interfaces
- Low (-65°C) to High (+250°C) temperature solutions available
- Vibration and shock load resistant designs
- Full range of feedback devices for speed, position and rotation
- Special custom designs available to meet your exact requirements

Standard Gearbox

- Six gearbox sizes
- 35, 37, 38, 39, 40, 42 Series
- Nine gearbox configurations
- Gear ratios: 1:1, 1.5:1, 2:1, 3:1, 4:1 as standard
- Special gear ratios available on request, e.g. 1.25:1
- Torque ratings up to 20000 Nm
- Option for reinforced shaft design for up to 300% higher torque transmission

Reliable Spiral Bevel Gear

With a proven design already used in millions of gearboxes, the Precision Spiral Bevel Gears, with accurate gear mesh, deliver high torque with smooth and quiet transmission.



Shaft Configurations

- 2, 3 or 4-way
- Solid or hollow shaft
- Special configurations available
- ROV torque receptacle integrated to gearbox drive
- ROV paddle adapter fitted to input drive shaft
- Motor adapter for direct connection of subsea motor to gearbox input
- Service life of 10,000 hours for all gearbox sizes
- Input speed up to 3,000 rpm maximum

Gearbox Housing

A rugged compact design made from a highly durable SG iron as standard or stainless steel on request.

It provides a strong housing that firmly and accurately holds the gear set in a reservoir of quality lubricant suited to the demands of subsea work.

Corrosion Protection

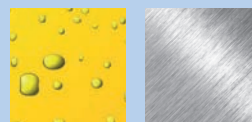

- To suit all economic needs
- Standard subsea paint finish
- Customer specified paint
- Plated finish
- Stainless steel

It can be engineered for the most demanding and complex applications. It's also defined by performance excellence, a long service life and a durability that's the hallmark of Power Jacks products. In short, the perfect solution for extreme subsea operations.

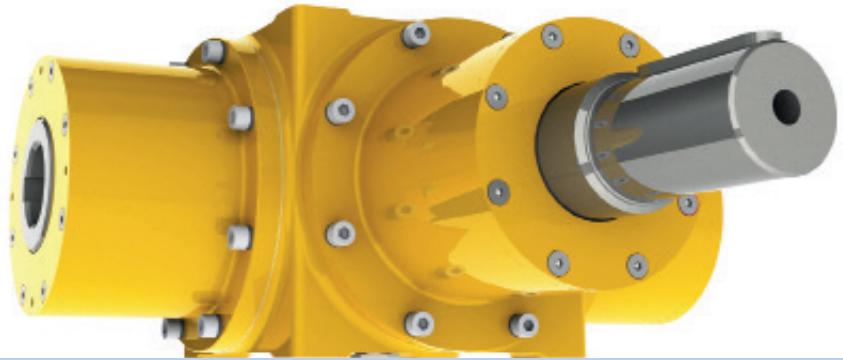

Solid Shaft

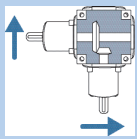

2 Way

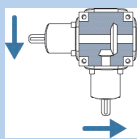

2 Way Reversed

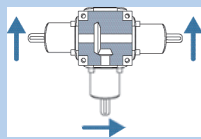

3 Way

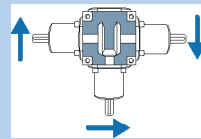

3 Way Reversed

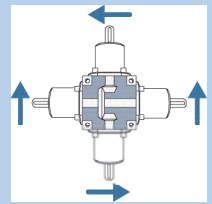

4 Way

Hollow Shaft

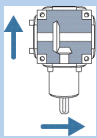

2 Way

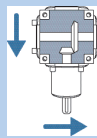

2 Way Reversed

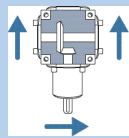

3 Way

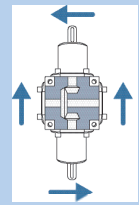

4 Way

Accessories



Hand Wheel



ROV Paddle Drive



ROV Lifting Handle



ROV Torque Receptacle

The Power Jacks

U-Series: Jacking Systems

SCREW JACKS CAN BE CONNECTED TOGETHER IN SYSTEMS SO THAT MULTIPLE UNITS CAN BE OPERATED AND CONTROLLED TOGETHER.

These arrangements or configurations can be built in many formats with the use of bevel gearboxes, motors, reduction gearboxes, drive shafts, couplings and motion control devices.

Four of the most popular system configurations are the 'H', 'U', 'T' and 'I' configured jacking systems. Note that multiple screw jacks can be linked together mechanically or electrically: the latter is useful if there is no space for linking drive shafts.

Jacking systems are not limited to the number of screw jacks shown here. They are regularly supplied to clients with 2, 4, 6, 8 jack systems. Larger systems can extend to 16 screw jacks or more. With the use of electronic synchronisation/control, multiple systems or screw jacks can be used in unison – extending the possible number of screw jacks used in unison to more than 100. To facilitate electronic control of screw jacks, feedback devices are available, mounted on the screw jack, bevel gearbox, motor or other system component.



"H" Configuration System

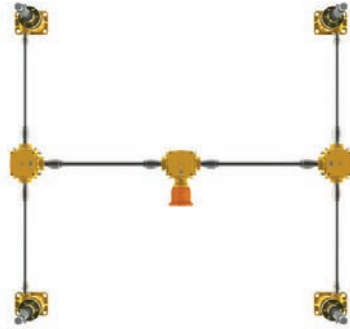

"U" Configuration System

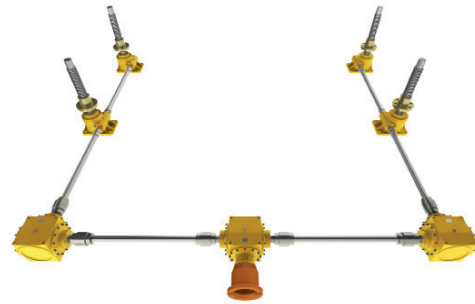
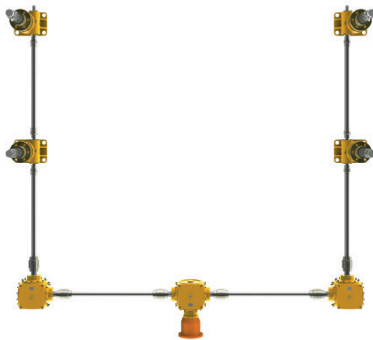

"I" Configuration System

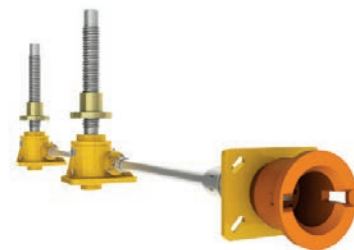
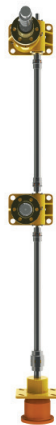

"T" Configuration System





Lifting & Positioning Solutions

Power Jacks are specialist industrial engineers providing design, manufacturing and services of quality industrial lifting, positioning and load monitoring equipment.

Our products are supplied globally across many sectors including Industrial Automation, Energy, Transport, Defence and Civil.

Power Jacks Ltd
Balmacassie Commercial Park
Ellon, AB41 8BX
Scotland (UK)
Tel: +44 (0)1358 285100

www.powerjacks.com
sales@powerjacks.com

PJB-U-EN-01

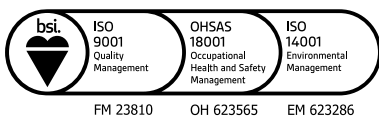

All information in this document is subject to change without notice. All rights reserved by Power Jacks Limited.
May not be copied in whole or in part. ©Power Jacks Limited 2017, Aberdeenshire, Scotland, United Kingdom.

Follow Us  Facebook  LinkedIn  Twitter